



BADEWANNE MIT SCHÜRZE WEISS GLANZ



BADEWANNE MIT SCHÜRZE HOLZOPTIK GRAIN

IRIS | OPTIK UND AUSFÜHRUNG DER SCHÜRZEN

ACRYLSCHÜRZEN

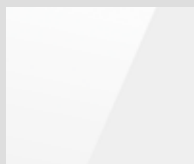

Weiß Glanz

SCHÜRZEN HOLZOPTIK



Weiß strukturiert



Grain



Burlington



Wenge

IRIS | FUNKTIONEN UND AUSSTATTUNG (je nach Version verfügbar)

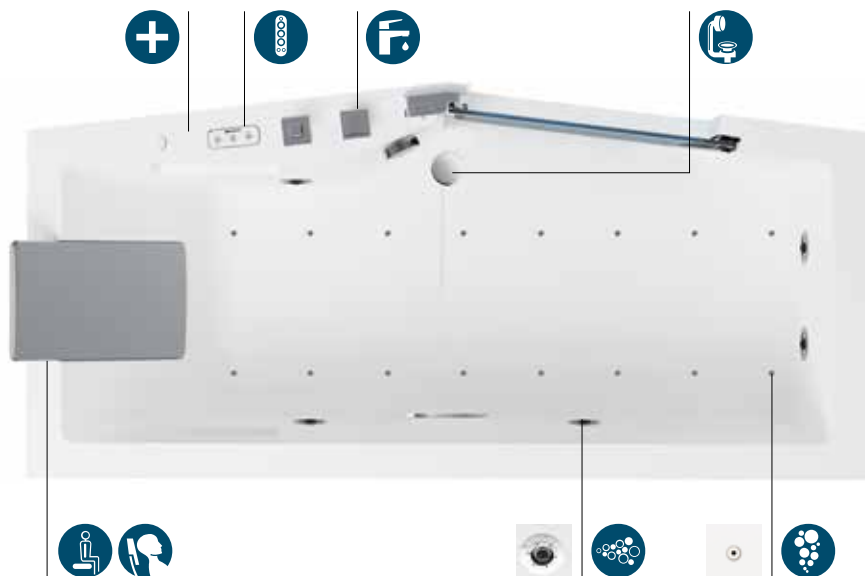

Airpool-Massage mit manueller oder sequenzieller Einstellung für eine effektive Stimulation der Körperzellen.



Whirlpool-Massage mit Ein- Ausschaltung des Whirlpoolsystems, elektr. Intensitätskontrolle und modulierender Intensität.



Nackensstütze / Sitz



Elektr. Bedienpaneel



Wannenrandarmatur



Ab- und Überlaufgarnitur



Desinfektionsanlage





BADEWANNE MIT SCHÜRZEN HOLZOPTIK BURLINGTON



Nackenstütze/Sky Sitz
Tragkraft 120 kg
56 x 24cm



Glastüre mit mechanischem
Verschluss



Wannenrandarmatur mit
2-Funktion Progressivmischer.
Wanneneinlauf am Überlauf.
Länge Handbrausenschlauch 60
cm und inkl. Handbrause 80cm
Bei 3 Bar Wasserdruck
15 l/min beim Wanneneinlauf und
7 l/min bei der Handbrause



Die Hydromassage von Novellini
erweckt alle Lebensgeister



IRIS

IRIS

BADEWANNE MIT TÜR

SCHÜRZEN ACRYL

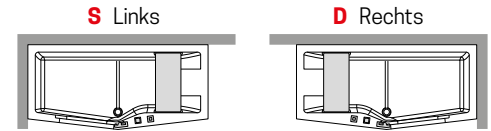

Mass			Kapazität	Code	Wahl der Wannenebefüllung			Eckmontage		Schürzen			
Cm	H	Lt.			Ab-Überlaufgarnitur (ohne Armatur)	Mit Wanneneinlauf am Überlauf f. Unterputzarmaturen	Ab-Überlaufgarnitur + Wanneneinlauf am Überlauf f. Unterputzarmaturen	Links	Rechts	Ohne Schürzen	1 Schürze	2 Schürzen	3 Schürzen
STANDARD MIT GESTELL													
					C	E		S-	D-	A0	A1	A2	A3
160x70/80	62	250		IRI216070									
170x70/80	62	265		IRI217080									
180x75/85	62	305		IRI218085									
STANDARD MIT GESTELL + WANNENRANDARMATUR													
							F	S-	D-	A0K	A1K	A2K	A3K
160x70/80	62	250		IRI216070									
170x70/80	62	265		IRI217080	-	-							
180x75/85	62	305		IRI218085									
HYDRO WHIRLPOOL + DESINFEKTIONSANLAGE													
					C	E	F	S-	D-	A0K	A1K	A2K	A3K
160x70/80	62	250		IRI316070T									
170x70/80	62	265		IRI317080T									
180x75/85	62	305		IRI318085T									
HYDRO PLUS													
					C	E	F	S-	D-	A0K	A1K	A2K	A3K
160x70/80	62	250		IRI416070T									
170x70/80	62	265		IRI417080T									
180x75/85	62	305		IRI418085T									

SCHÜRZEN HPL LAMINAT

Mass			Kapazität	Code	Wahl der Wannenebefüllung			Eckmontage		Schürzen						
Cm	H	Lt.			Ab-Überlaufgarnitur (ohne Armatur)	Mit Wanneneinlauf am Überlauf f. Unterputzarmaturen	Ab-Überlaufgarnitur + Wanneneinlauf am Überlauf f. Unterputzarmaturen	Links	Rechts	1 Schürze	2 Schürzen	3 Schürzen	Weiß strukturiert	Grain	Burlington	Wenge
STANDARD MIT GESTELL																
					C	E		S-	D-	A1	A2	A3	I	M	N	V
160x70/80	62	250		IRI216070												
170x70/80	62	265		IRI217080												
180x75/85	62	305		IRI218085												
STANDARD MIT GESTELL + WANNENRANDARMATUR																
							F	S-	D-	A1	A2	A3	I	M	N	V
160x70/80	62	250		IRI216070												
170x70/80	62	265		IRI217080	-	-										
180x75/85	62	305		IRI218085												
HYDRO WHIRLPOOL + DESINFEKTIONSANLAGE																
					C	E	F	S-	D-	A1	A2	A3	I	M	N	V
160x70/80	62	250		IRI316070T												
170x70/80	62	265		IRI317080T												
180x75/85	62	305		IRI318085T												
HYDRO PLUS																
					C	E	F	S-	D-	A1	A2	A3	I	M	N	V
160x70/80	62	250		IRI416070T												
170x70/80	62	265		IRI417080T												
180x75/85	62	305		IRI418085T												

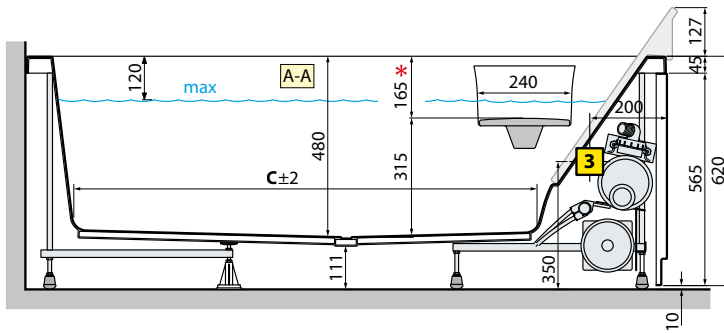

* 145 mm Modell 160x70/80

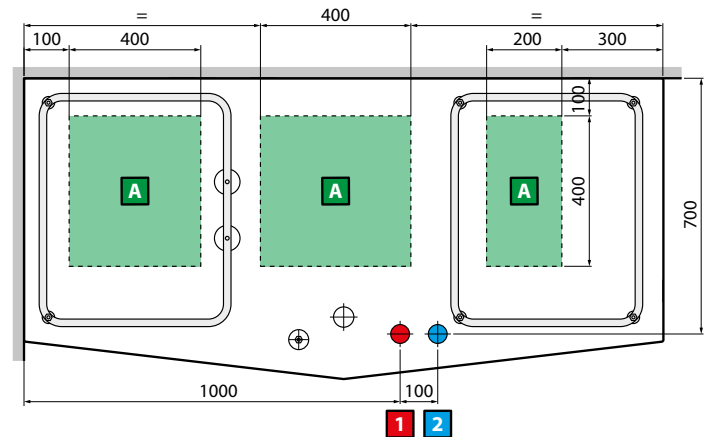
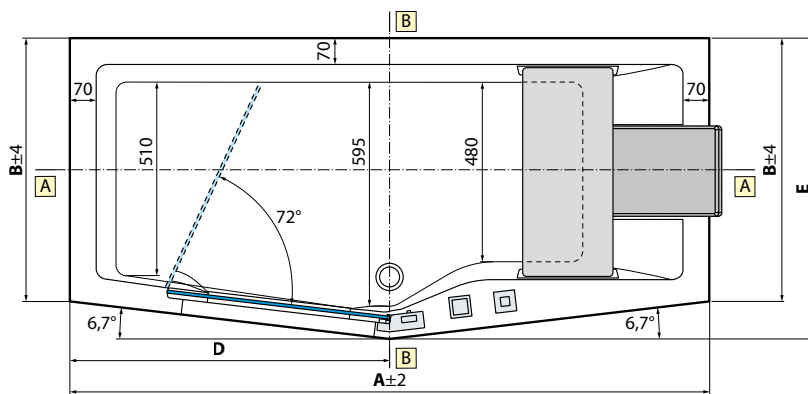
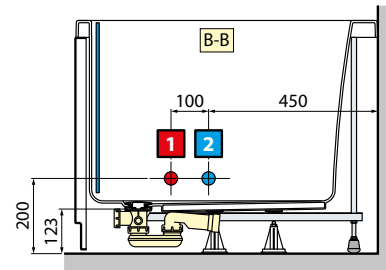
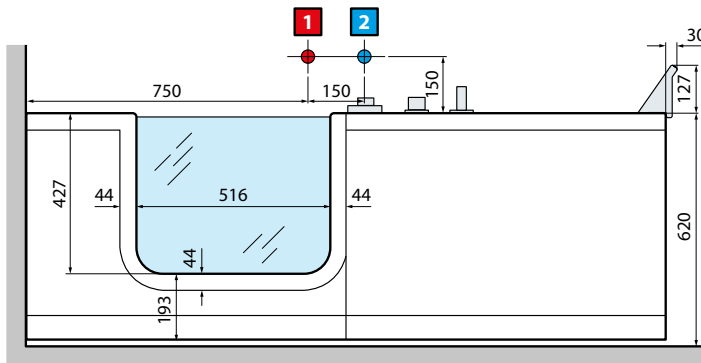

Modelle	A	B	C	D	E	Kapazität lt
160x70/80	1600	700	1140	860	800	250
170x70/80	1700	700	1235	850	800	265
180x75/85	1800	750	1345	860	850	305

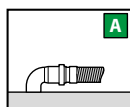
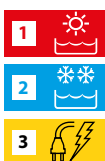

ACHTUNG!
Kann für Personen mit
Herzschrittmacher gefährlich sein.

Vor der Installation der elektrischen Anlage muss ein 30mA Differentialschalter mit allpoliger Schaltereinheit eingebaut werden, mit einer Öffnung der Kontakte von mindestens 3 mm.

TECHNISCHE EIGENSCHAFTEN

6 Whirldüsen
16 Airdüsen
Abflussanschluss 1 1/2"

ELEKTRISCHE ANSCHLUSSWERTE

Spannung 220-230 V
Frequenz 50 Hz
Gesamt-Anschlusswerte: 950 W
Whirlpool: 550 W
Airpool: 400 W

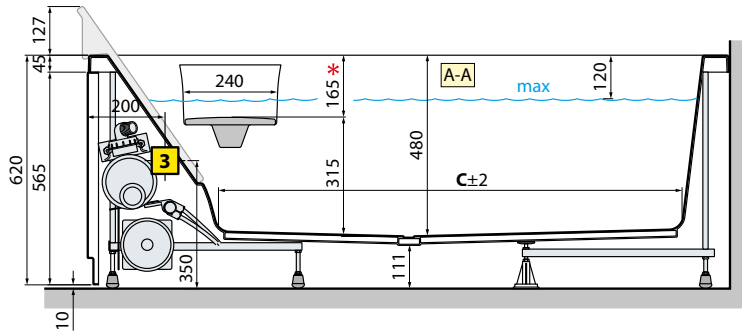

* 145 mm Modell 160x70/80

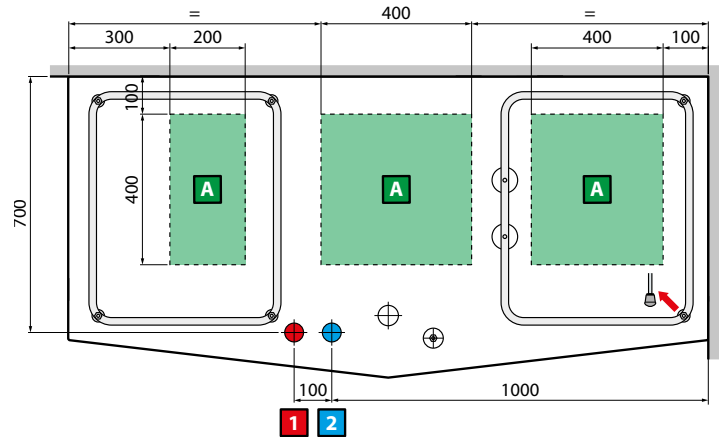
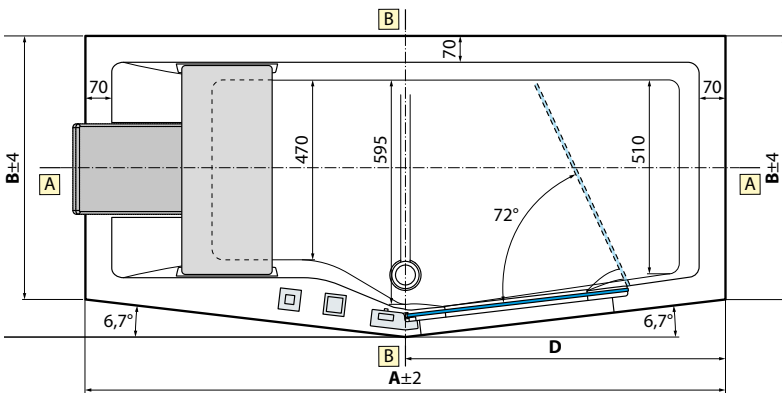
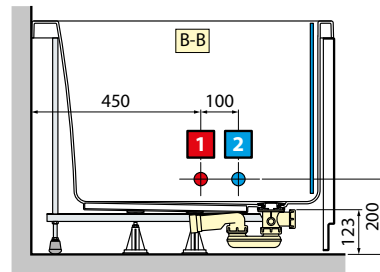
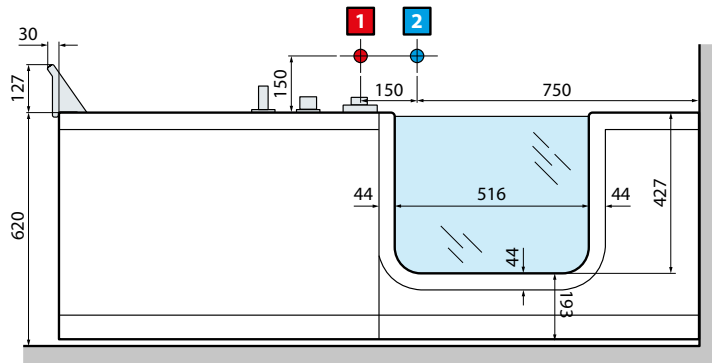

Modelle	A	B	C	D	E	Kapazität lt
160x70/80	1600	700	1140	860	800	250
170x70/80	1700	700	1235	850	800	265
180x75/85	1800	750	1345	860	850	305

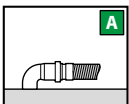

ACHTUNG!
Kann für Personen mit
Herzschrittmacher gefährlich sein.

Vor der Installation der elektrischen Anlage muss ein 30mA Differentialschalter mit allpoliger Schalteinheit eingebaut werden, mit einer Öffnung der Kontakte von mindestens 3 mm.

TECHNISCHE EIGENSCHAFTEN

6 Whirldüsen
16 Airdüsen
Abflussanschluss 1 1/2"

ELEKTRISCHE ANSCHLUSSWERTE

Spannung 220-230 V
Frequenz 50 Hz
Gesamt-Anschlusswerte: 950 W
Whirlpool: 550 W
Airpool: 400 W